



EAO, København, 2012

Future perspectives of implant prosthetics

Asbjørn Jokstad
University of Toronto, Canada
& University of Tromsø, Norway

Microprocessor performance

Clock speed (MHz)

<1	1971	Intel4004/ Texas Instrument TMS100
1	1974	Motorola/Intel8008/ZilogZ80 <u>8bit.Cp/M</u> (Commodore 64, Apple II)
4.77	1976/8	Intel 8086 <u>16bit</u> ; (Compaq, IBM PC); Intel 8088 (IBM (1981))
8	1978	Motorola 68000 (Macintosh128k, Amiga1000)
6 – 25	1982-85	Intel 80286 <u>DOS(1981)</u> ; (IBM-AT (1984))
12 – 40	1985-90	Intel 80386 <u>32bit</u> ; Motorola 68040 (Macintosh, Amiga, NeXT))
20 – 100	1989-94	Intel i486; Cyrix
	1993-95	Intel Pentium, Pentium MMX → Pentium Pro
110	1994	IBM PowerPC 601 (Power Macintosh 8100)
133	1996	AMD K5
500	1997	IBM PowerPC 750 (iMac)



From: <http://www.old-computers.com/museum>



Microprocessor performance

(The clock rate is no longer considered as a reliable benchmark since there are different instruction set architectures & different microarchitectures – MIPS more common today)

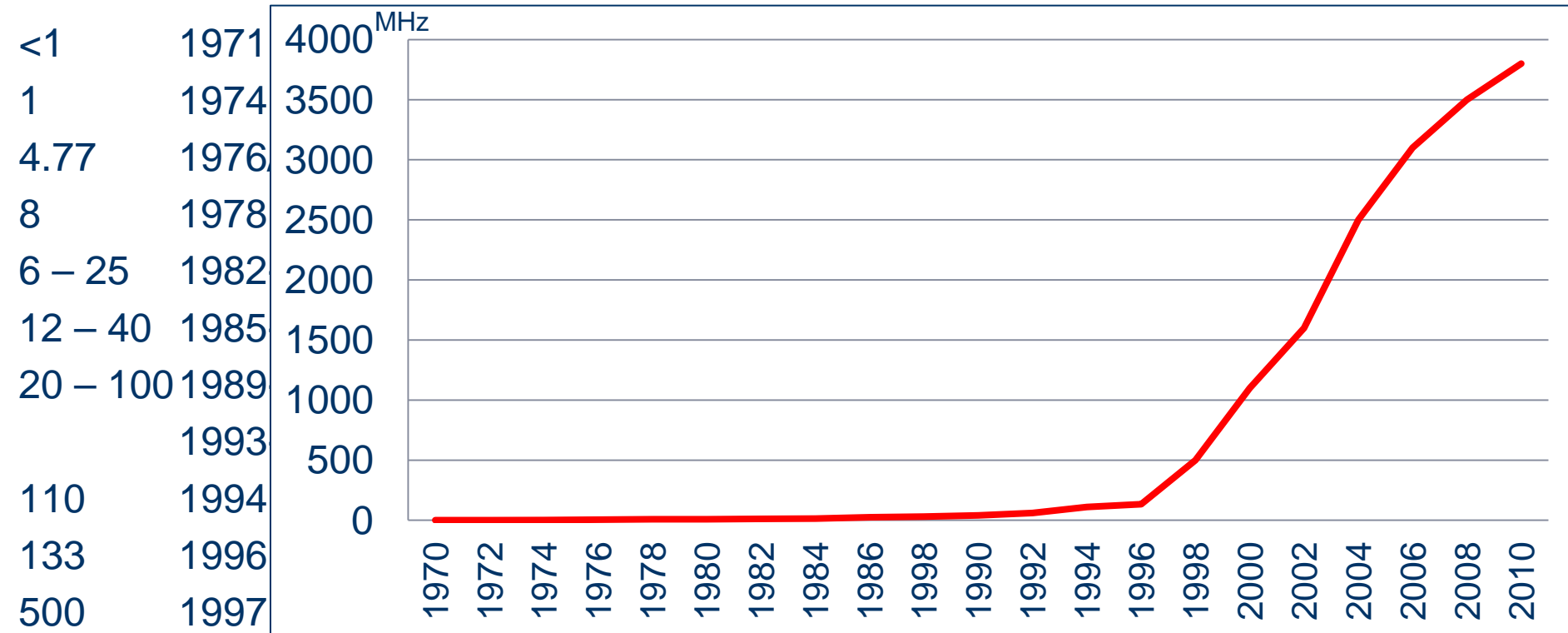

0.6 → 1400 1997-2002 Intel Pentium III (Celeron/Zeon)

0.8 → 3000 2001 IBM PowerPC950 (PowerPC G5)

1.3 → 3800 2000-2008 Intel Pentium 4 (Pentium M/D)

1 → 3000 2003 AMD Athlon 64 → 64X2

3300 2011 Intel Core i7

Microprocessor uses in the dental clinic

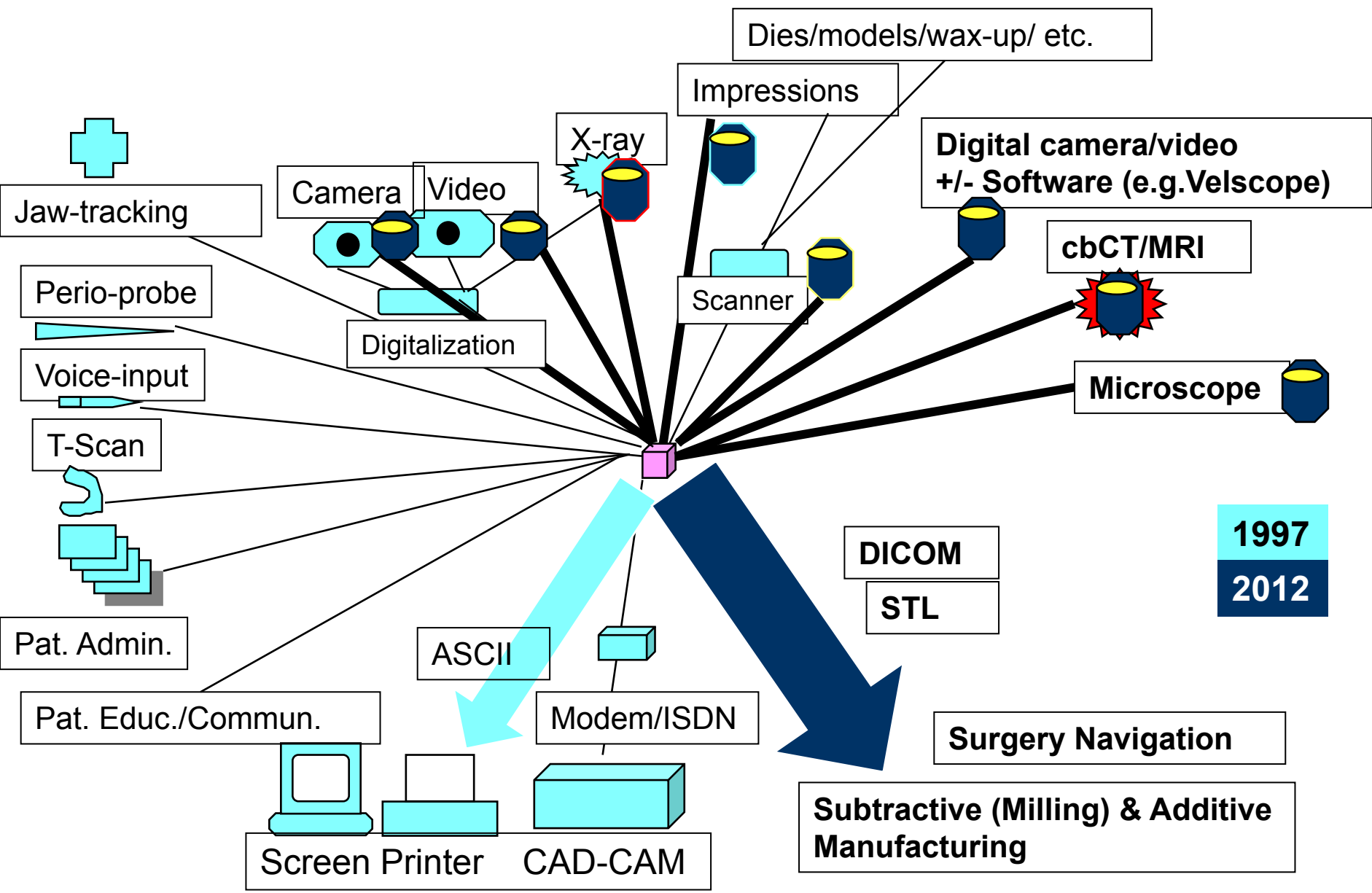

Computer-aid/-assistance in dentistry

Engineering & Production

Computer-aided design “CAD”

Computer-aided drafting

Computer-aided engineering

Computer-aided manufacturing “CAM”

Computer-aided quality

Computer-aided maintenance

Health Care

Computer-assisted detection

Computer-aided diagnosis

Computer-aided tomography

Computer-assisted surgery

Teaching

Computer assisted instruction

Computer assisted/based learning

Computer-assisted assessment

Communication

Computer-assisted personal interviewing

Computer-assisted telephone interviewing

Computer-assisted reporting

Dental Clinic

Computer-aided shade-matching

The diffusion of innovations

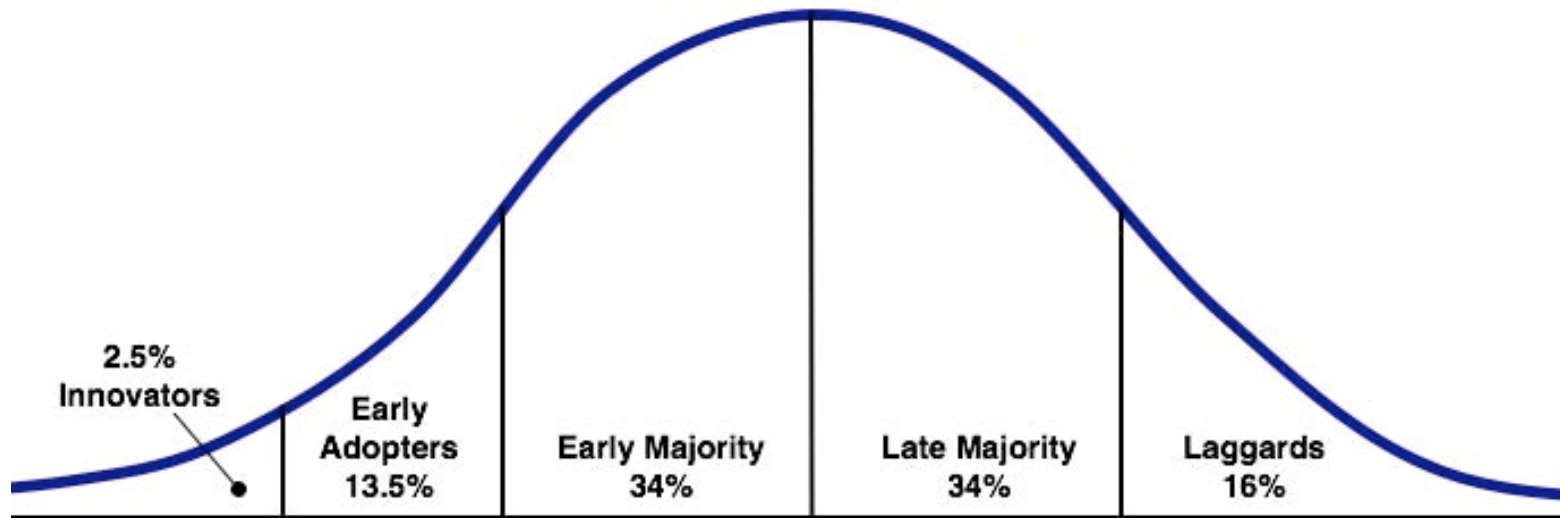

- People have different levels of readiness for adopting new innovations
- Clinicians can be classified into five groups
- The characteristics of a product affect overall adoption.

The early adopters ~10 years ago

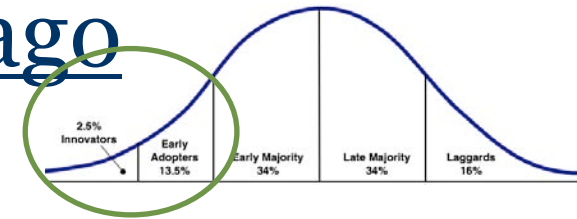

cad-esthetics® /DECIM
Cercon smart ceramics®
Cerec® 1→3 / InLab®
DCS Precident®
Digident®
KaVo Everest®
Lava® system



Compact unit: Digital acquisition + Design-software +
Manufacturer-software + CNC-Milling (Al_2O_3 -ceramic)

(Non-digital alternative: Copy milling (e.g. Celay)



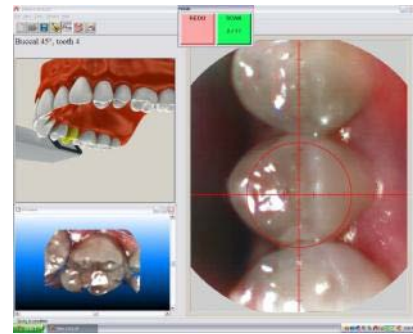
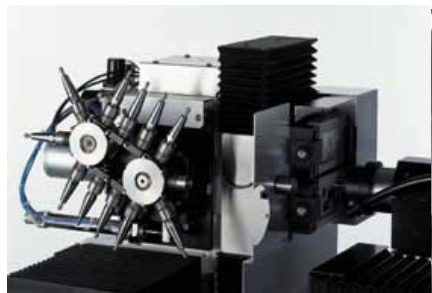

Manufacture Process

Device
Applications
Materials

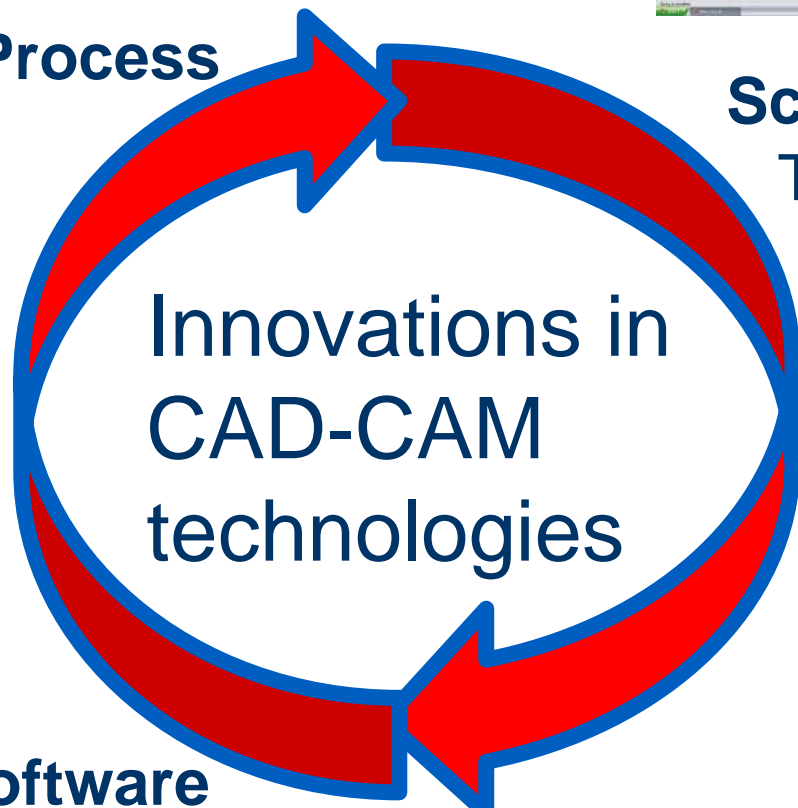

Innovations in
CAD-CAM
technologies

Scanning

Technology
Acquisition
Scan Items
Data export format(s)

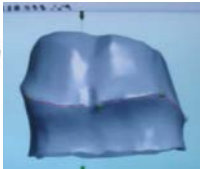

Manufacture Software

Data import/export formats/
formatting
Manufacturing applications

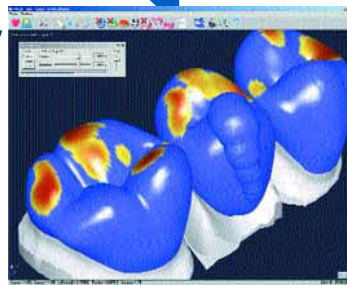

Design Software

Data import/export
formats / formatting
Design applications

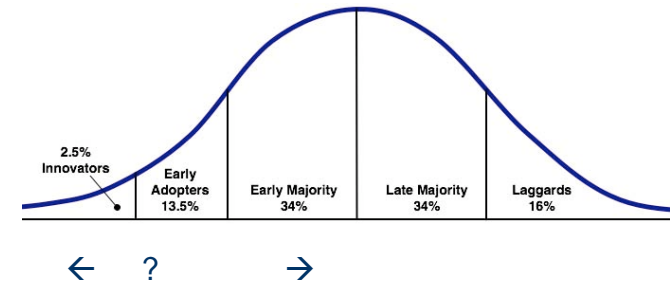

INNOVATIONS IN SCANNING DEVICES

Scanning - Parameters

Technology

Optical-white light

Optical-blue light

Optical-stripe light

Optical-laser/video

Optical-laser-triangulate **Scan export format**

Optical-laser-confocal Open format (STL, DICOM)

Mechanico-electric (laser-adjusted)

Conoscopic Holography

Acquisition

Intra-oral

Extra-oral

Intra-& extra-oral

Open format (STL, DICOM)

Closed

Scan Items

Antagonist

Bite registration

Die

Full arch

Implant Abutment

Model

Prostheses

Wax-up

ISO-standard(?)

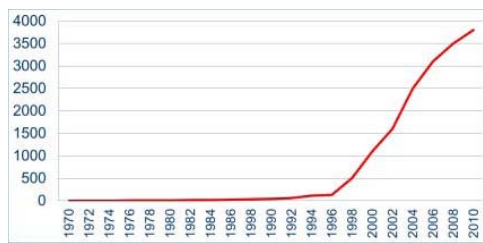

Intra oral scanning



CEREC
BlueCam
/ AC

Laser Triangulation

Confocal light

Per 2010;
4 systems
(+E4D)



LAVA COS
(2008)



Cadent Itero
(2006)

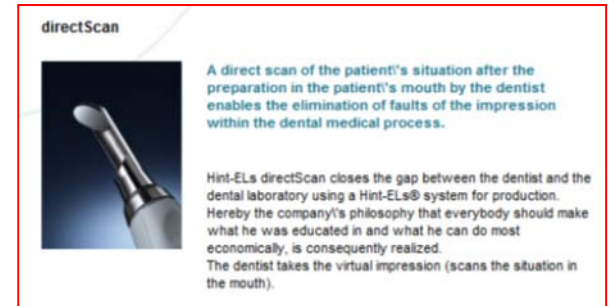

Hint-ELs GmbH (2009)

Intra oral scanning



CEREC



LAVA COS



Cadent Itero

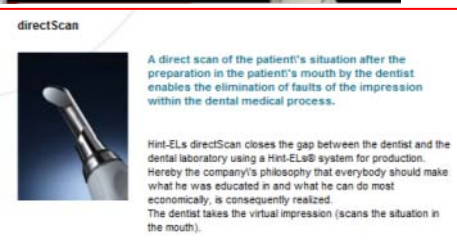

Hint-Els GmbH

Per 2010/2011:
4 additional systems introduced

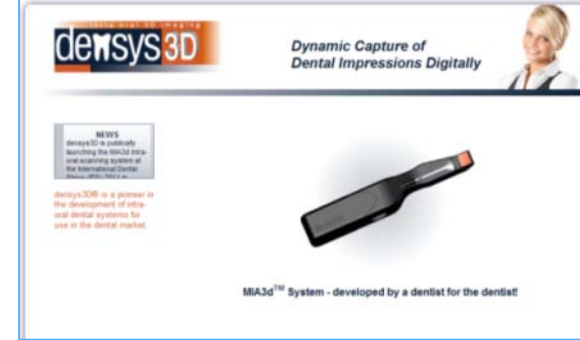

Densys3D: MIA3d



Intellidenta/ Clon3D: IODIS

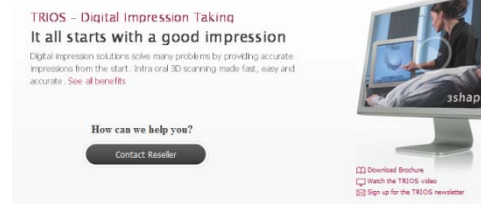

3Shape: TRIOS /(Dentaswiss)



MHT: Cyrtina/3DP Progress

Intra oral scanning

Per 2012: 3 additional systems introduced

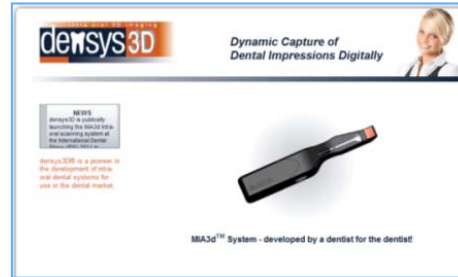

Zfx / Intrascan

BLUESCAN-I INTRAORAL 3D SCANNER



Bluescan /a.tron3D

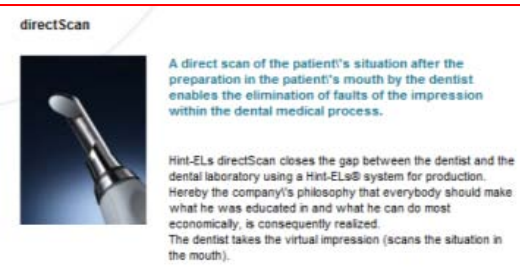

IOS: Fastscan

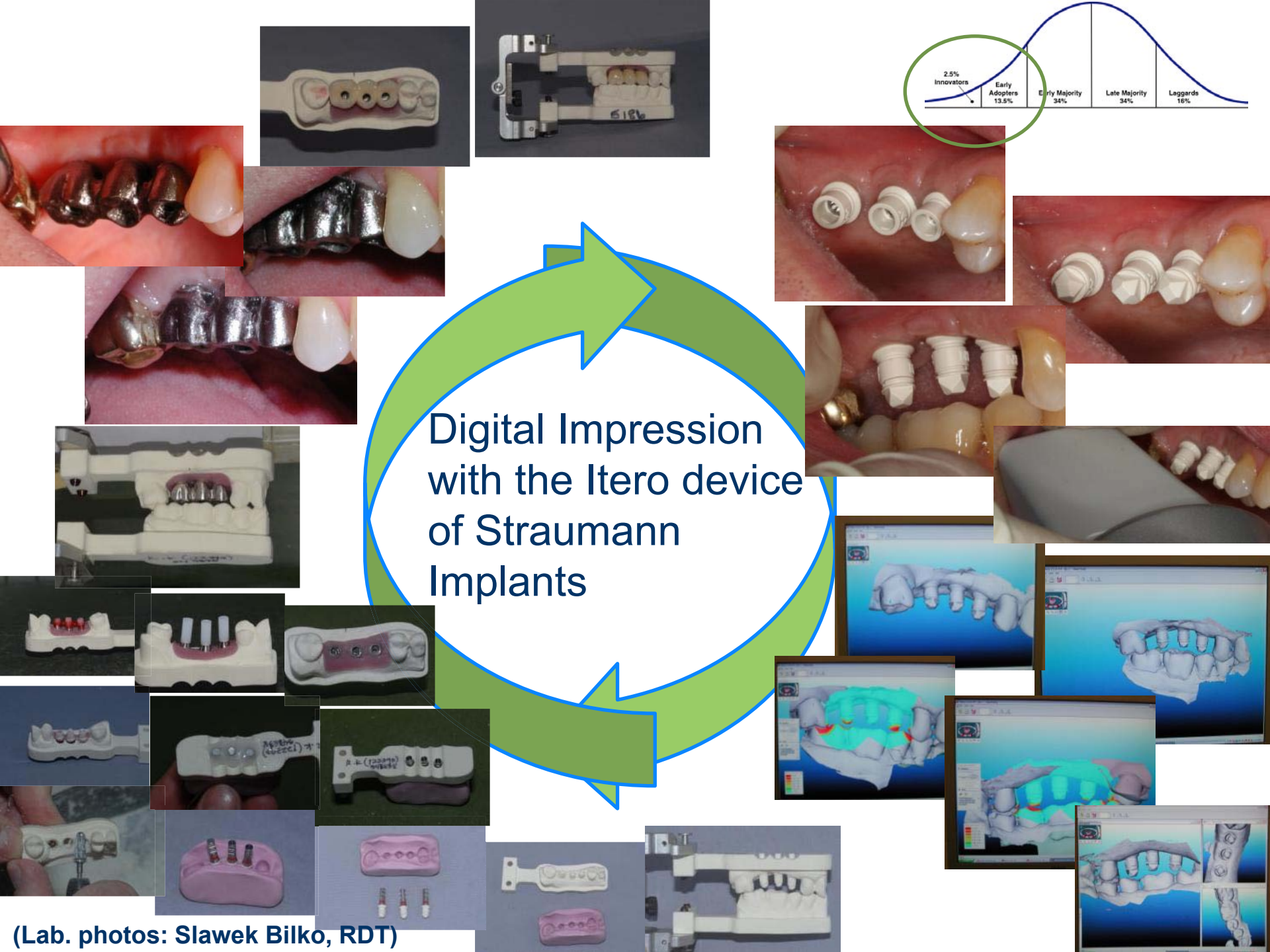
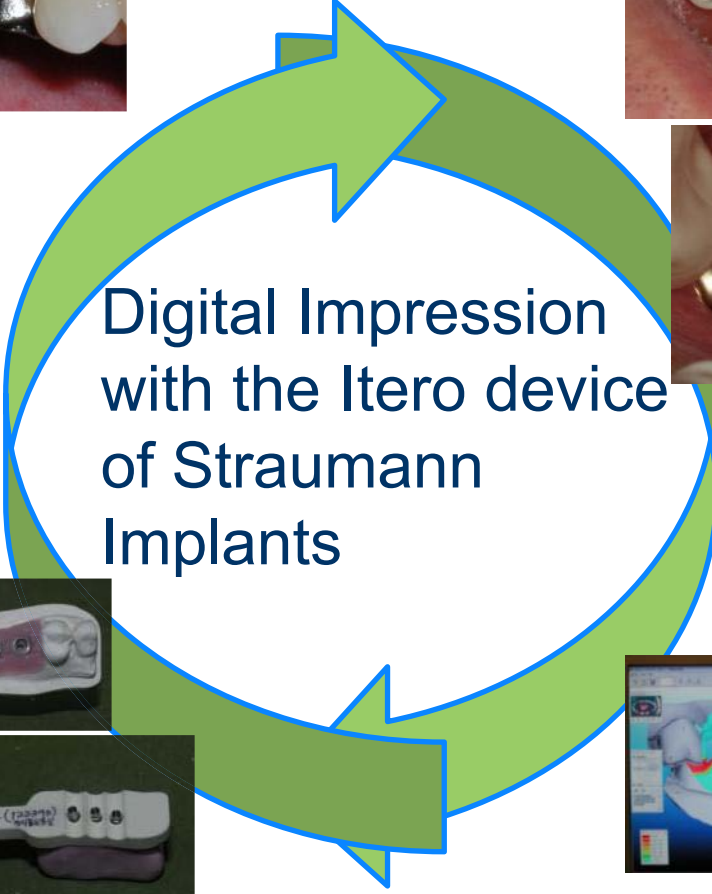
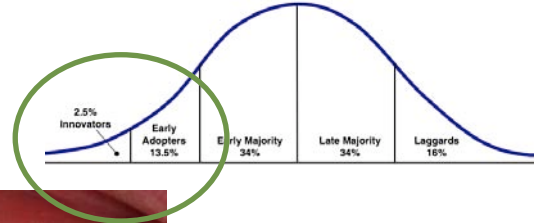

(Lab. photos: Slawek Bilko, RDT)

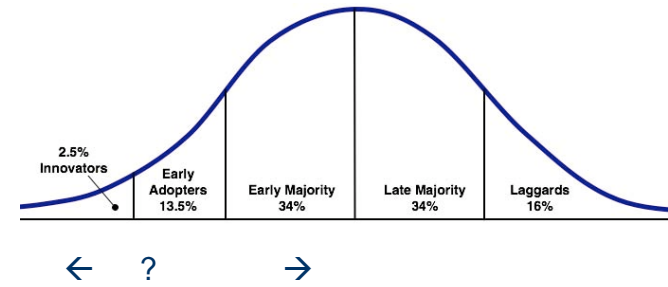

INNOVATIONS IN DESIGN & MANUFACTURER SOFTWARE

The sum of Hardware + Software Improvements

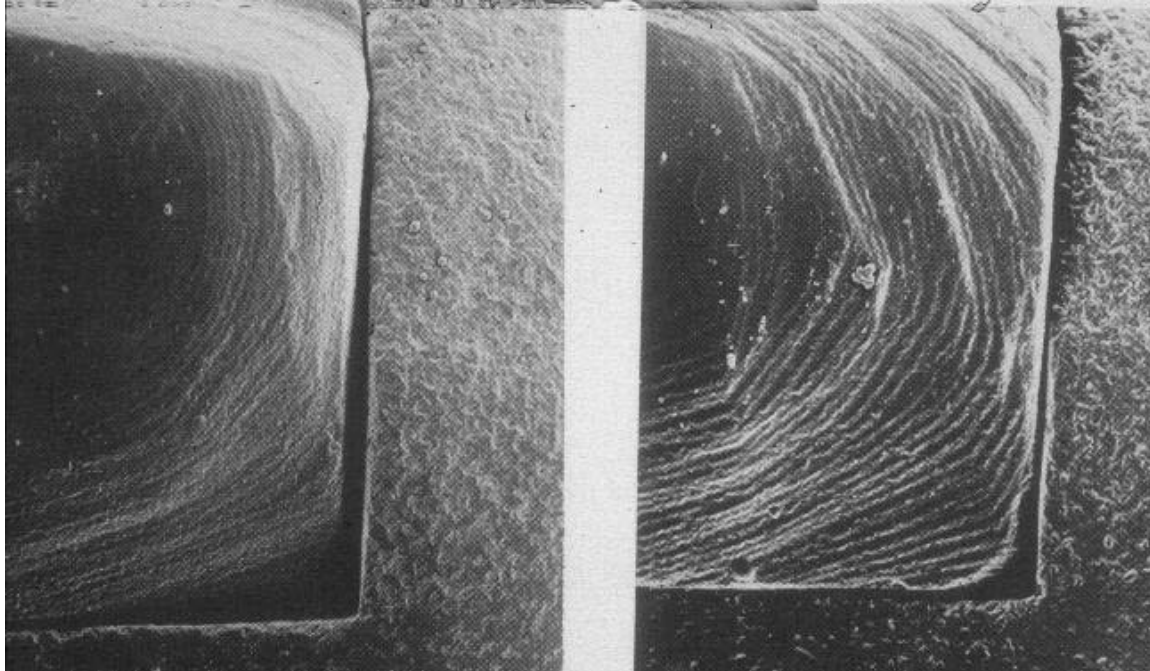

CEREC 1
(~1986)

CEREC 2
(~1992)

Design / Manufacturer Software Parameters

Import format(s)

Open

Scanner-CAD bundled (Closed)

Export format(s)

Open (e.g. STL)

CAD-CAM bundled (Closed)

Applications

Wax-ups / temporaries

Inlays / Onlays

Single-unit copings

Crowns / monolithic crowns

3 → 16u / 4 → 7cm –FDPs

Removable Dental Prosthesis
(Partial / Full)

Implant “customised” abutments

Implant meso-structures

Implant-Bars

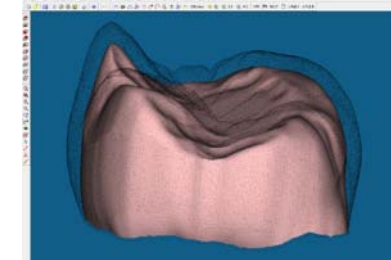
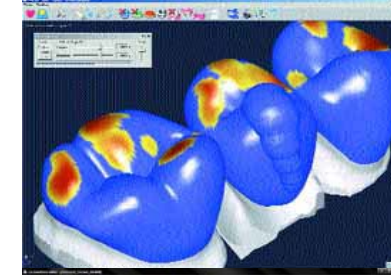
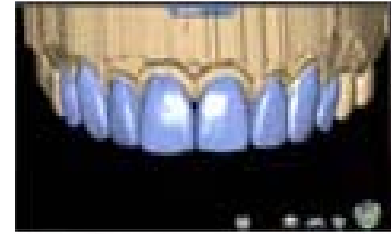

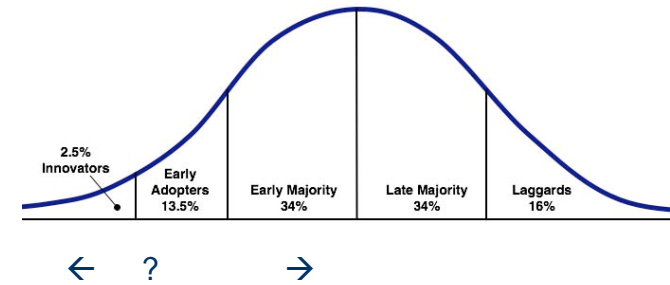

INNOVATIONS IN ADDITIVE AND SUBTRACTIVE MANUFACTURING CONCEPTS

Manufacturing Parameters

Device - additive

3D Laser sintering

3D Printing

Device - subtractive

3/3.5/4/5/6-axis-milling

Applications

Wax-ups

In-/Onlays

Single-unit copings

Crowns

Monolithic Crowns

3 → 16unit(/4 → 7cm)-FDPs

Custom abutments

Implant-Bars

implant-suprastructure-Meso-structures

Partial Removable Prosthesis

Full Removable Prosthesis

Materials

Base alloys

Gold alloys

Non-precious alloys

Titanium / -alloys

Composite resins

Cast Resins / Wax

PMMA

In-Ceram (Porous Al_2O_3)

Al_2O_3 (sintered)

Feldspathic

$\text{Li}_2\text{Si}_2\text{O}_5$

ZrO_2 (porous/green state)

ZrO_2 (pre-sintered state)

ZrO_2 (sintered)

ZrO_2 (sintered & HIP-ed state)

with / without

Sintering-furnace



Milling in Dentistry – From 3 axes

→ 5 → 5+5 milling axes

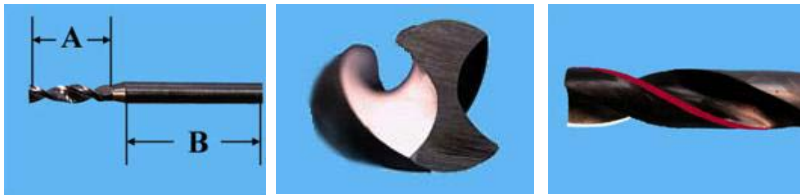
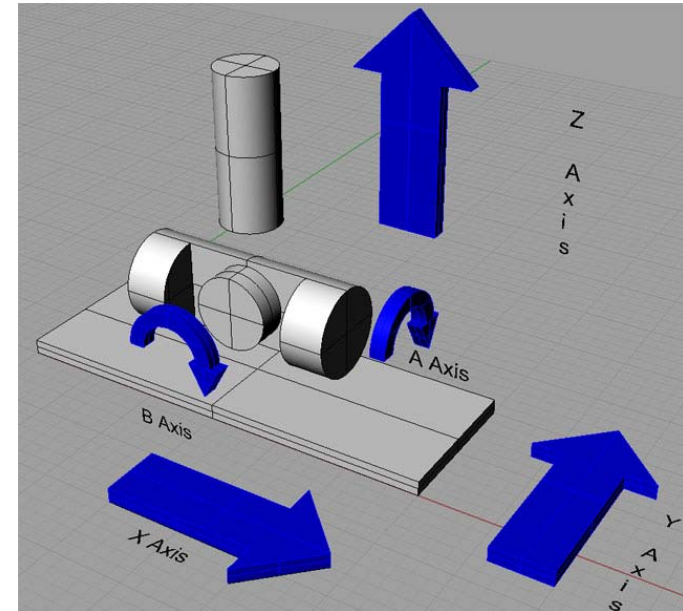

Milling machines today are manually operated, mechanically automated, or digitally automated via computer numerical control (CNC) re. e.g. torques, feed-rate, nature of cutters, etc..

Software algorithm compensation for errors introduced during milling processes

Often based on finite-element-modeling calculations

- Geometrical compensation
- Force compensation
- Thermal compensation
- Errors in the final dimensions of the machined part are determined by the accuracy with which the commanded tool trajectory is followed, combined with any deflections of the tool, parts/fixture, or machine caused by the cutting forces
- The effect of geometric errors in the machine structure is determined by the sophistication of the error compensation algorithms
- The cutting tools' trajectories are subject to performance of the axis drives and the quality of the control algorithms



Cutters for dental (5 axis) milling



Milling Bur 4 L
Used to mill pre-sintered zirconia (rough preliminary and internal milling)



Milling Bur 3 L
Used to mill pre-sintered zirconia (rough milling)



Milling Bur 2 L
Used to mill pre-sintered zirconia (defined milling/precise milling)



Milling Bur 1 L
Used to mill pre-sintered zirconia (precise milling)



Milling Bur 0,5 S
Used to mill pre-sintered zirconia (high precision milling)



Milling Bur 1 XXL
Used to mill pre-sintered zirconia (abutment)



Milling Bur 2 A
Used to mill pre-sintered zirconia (abutment)



Milling Bur 1,5 A
Used to mill pre-sintered zirconia (abutment)



Milling Bur 0,5 A
Used to mill pre-sintered zirconia (abutment)



Milling Bur 2W30
Used to mill screw seats



Milling Bur 3 C
Used to mill pre-sintered zirconia (2° coned flank)



Milling-Bur-1-XL
Used to mill pre-sintered zirconia (precise milling of deep)



Milling-Bur-3-U
Used to mill pre-sintered zirconia (undercut)



Milling-Bur-2-U
Used to mill pre-sintered zirconia (undercut)



Round-Head-Bur-2-K
Rapid and easy smoothing of surfaces and undercuts



Milling-Bur-0,3-C
Used to mill occlusal fissures



Milling-Bur-2-UR
Used to mill undercuts



Milling-Bur-2,5-UR
Used to mill undercuts

Emerging Additive manufacturing technologies

E.g.: 3D printing / Additive (freeform) fabrication / Layered manufacturing / Rapid prototyping/-manufacturing / Robocasting /Solid freeform fabrication (SFF)

3D geometries physically constructed directly from 3D CAD.

Process introduced in the mid-1980s. Original name was rapid prototyping since the first use was to make prototypes of parts without having to invest the time or resources to develop tooling or other traditional methods.

As the process and quality controls have evolved additive manufacturing has grown to include production applications

Comparison of solid freeform fabrications methods

Method	Accuracy (mm/mm) ^[6]	Maximum part size (mm) ^[7]	Process time (hh:mm) ^[8]
Fused deposition modelling	0.005	254 x 254 x 254 (Stratasys) ^[9]	12:39
Laminated object modeling	0.01	812 x 558 x 508 (Cubic Technologies)	11:02
Selective laser sintering	0.005	381 x 330 x 457 (3D Systems)	4:55
Solid ground curing	0.006	508 x 355 x 508 (Cubital)	11:21
Stereolithography	0.003	990 x 787 x 508 (Sony)	7:03
Robocasting	0.1 (Fab@Home ↗)	240 x 240 X 240 (Fab@Home ↗)	TBD

Additive manufacturing: Selective Laser Sintering (SLS)

A high power laser (e.g., CO₂) fuse small particles of plastic, metal, ceramic, or glass powders into a desired 3-dimensional shape.

The laser selectively fuses powdered material by scanning cross-sections generated from a 3-D digital description of the part on the surface of a powder bed.

After each cross-section is scanned, the powder bed is lowered by one layer thickness, a new layer of material is applied on top, and the process is repeated until the part is completed.

SLS does not require support structures due to the fact that the part being constructed is surrounded by unsintered powder at all times

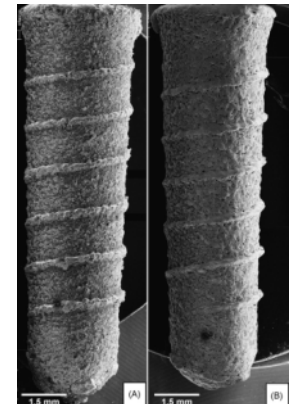
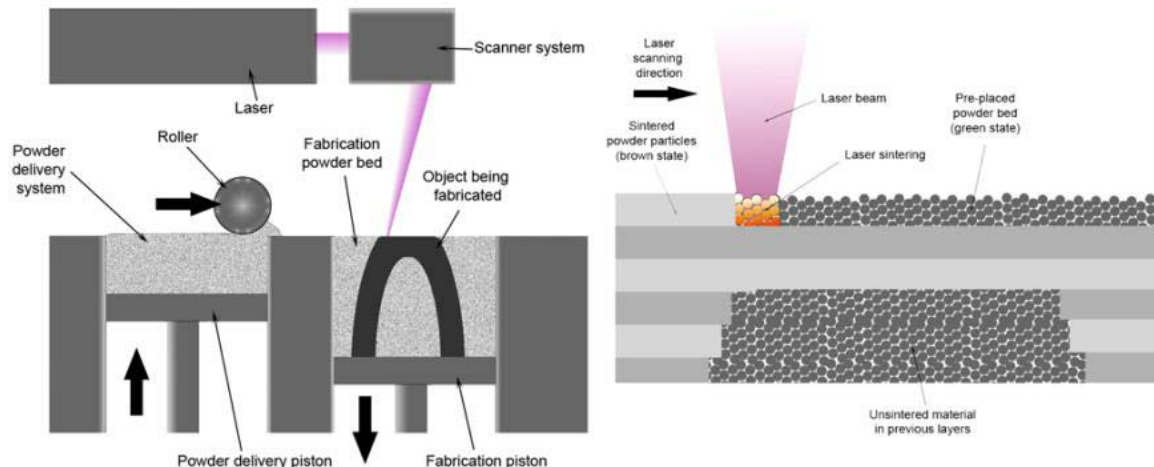

From: Traini ea Dent Mater 2008

Additive manufacturing: Stereolithography (SL / SLA)

The method and apparatus make solid objects by successively “printing” thin layers of an UV-curable material one on top of the other.

The concentrated UV-light-beam focuses onto the surface of a vat filled with liquid photopolymer. The light beam draws the object onto the surface of the liquid layer by layer, causing polymerization or cross-linking to give a solid.

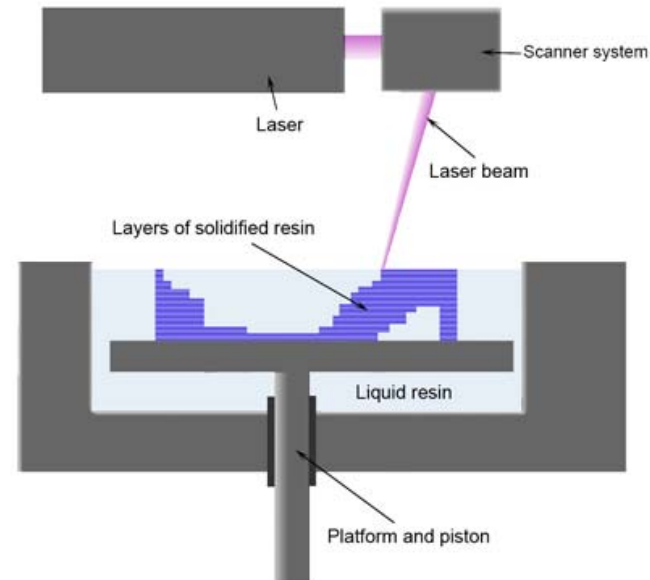
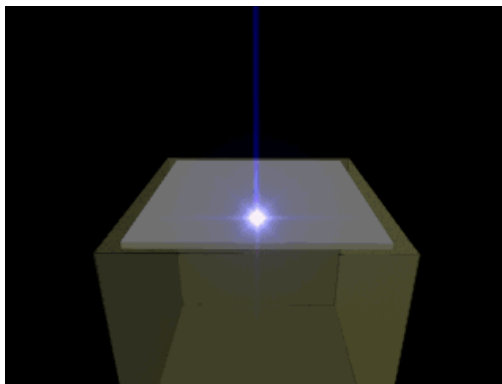

Additive manufacturing: Robocasting

A material is deposited at room-temperature material -- in the form of a viscous gel or ceramic slurry -- from a robotically controlled syringe or extrusion head.

The material hardens or cures after deposition

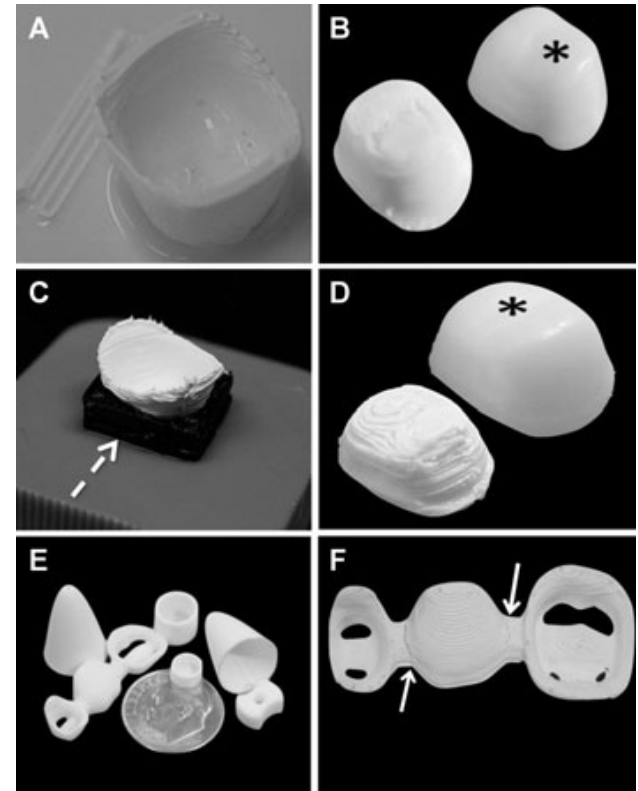
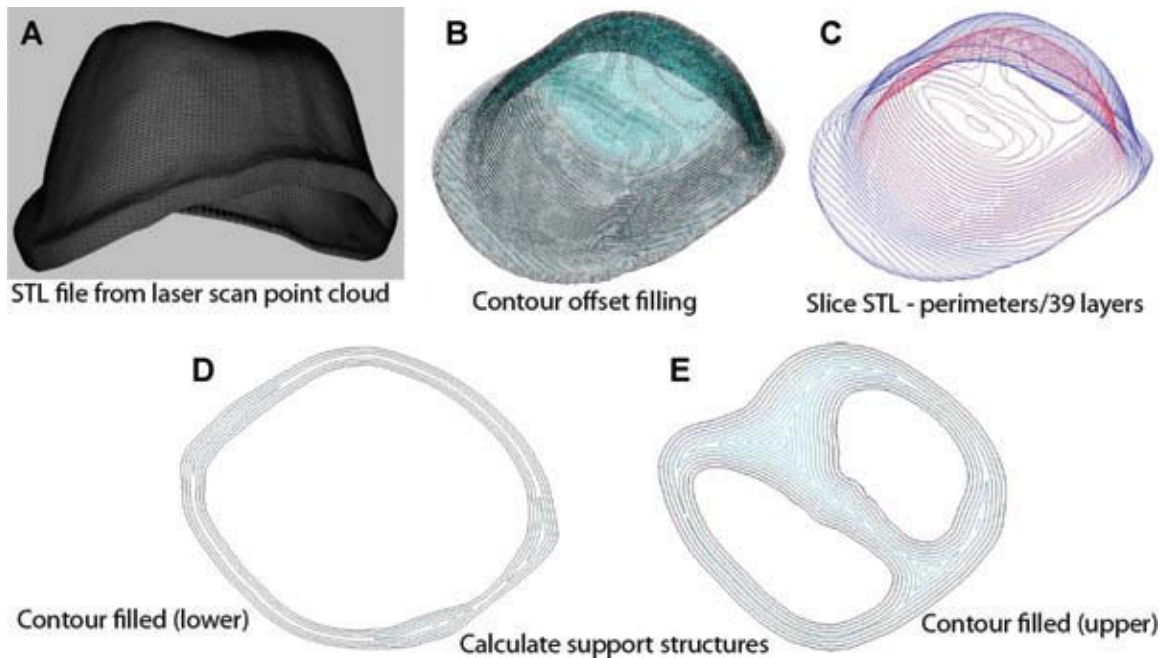

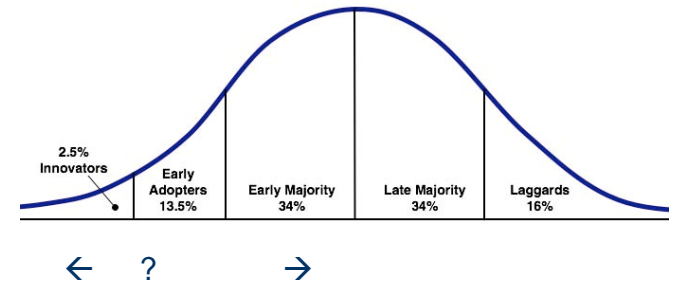

INNOVATIONS IN RESTORATIVE MATERIALS

Zirconia milling substrates are not all alike!

		%
TZP*	$\text{ZrO}_2 / \text{Y}_2\text{O}_3$	95 / 5
TZP-A	$\text{ZrO}_2 / \text{Y}_2\text{O}_3 / \text{Al}_2\text{O}_3$	~95 / ~5 / 0.25
FSZ	$\text{ZrO}_2 / \text{Y}_2\text{O}_3$	90 / 10
PSZ	$\text{ZrO}_2 / \text{MgO}$	96.5 / 3.5
ATZ	$\text{ZrO}_2 / \text{Al}_2\text{O}_3 / \text{Y}_2\text{O}_3$	76 / 20 / 4

Great variations regarding:

Hardness

Fracture resistance

Grain size

Tension strength

Elasticity module

Opacity

Sintering time

Who do you believe checks:

Veneering ceramic compatibility?

Optimal core-veneer layering thickness?

*TZP=(tetragonal zirconia polycrystals)



Zirconia milling substrates are not all alike!

Partially sintered

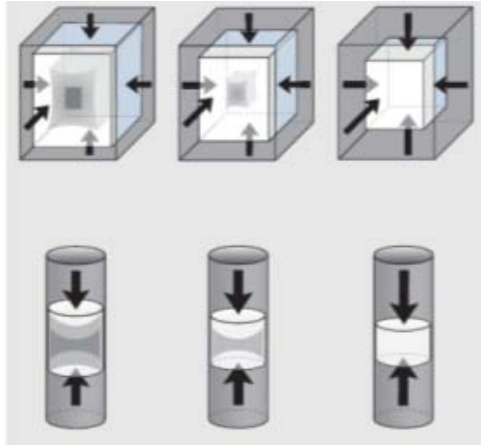
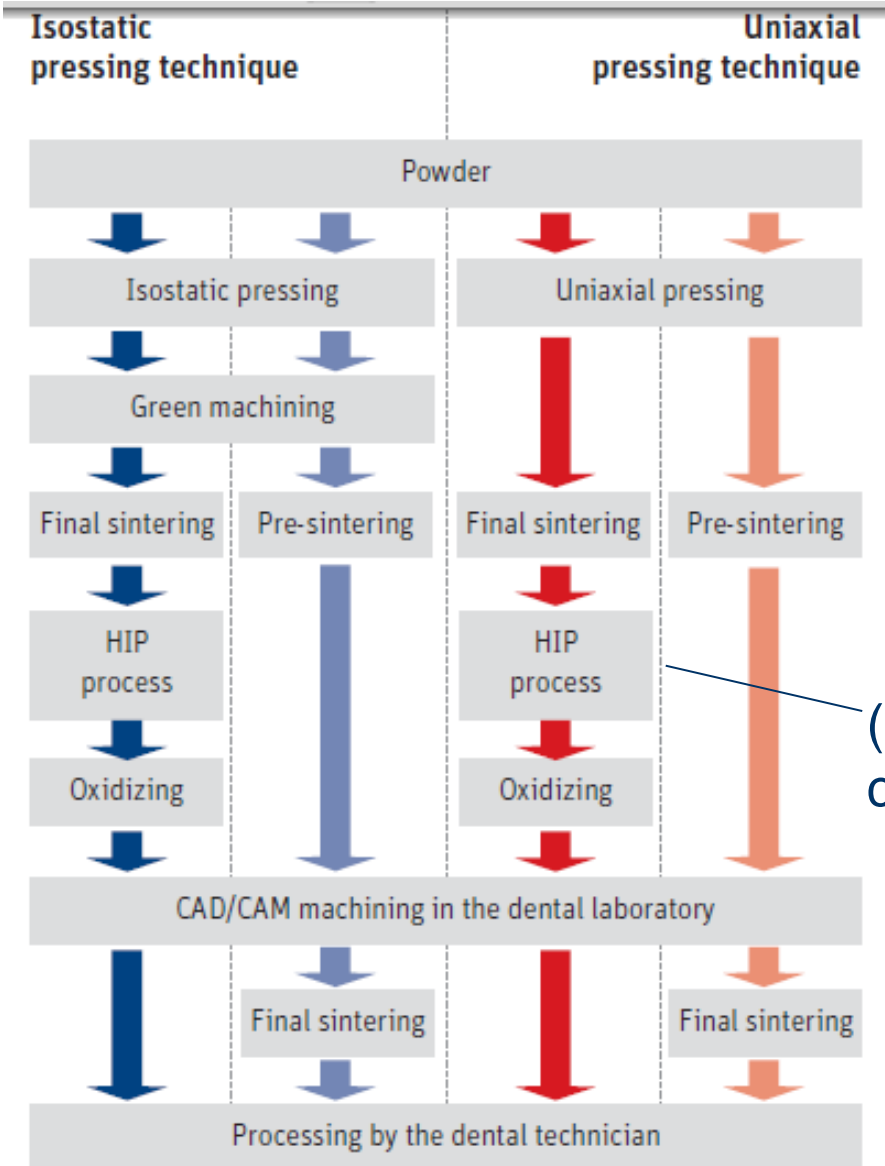

(HIP process: hot isostatic post compaction)

Final sintering: ~1350°C (cercon)
 -1500°C (lava) -1530°C (vita)

Prefabricated blanks for supra-construction

examples



Sirona



ø99 mm x 10 - 25mm



DCS (Hip)

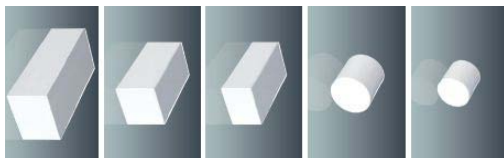

KaVo Everest



E4D

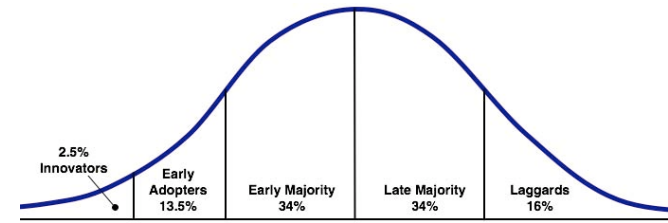

Rapid Developments combined with compressed learning curves of using

- scanning technologies
- design (“CAD”) software
- manufacture (“CAM”) software
- additive/subtractive manufacture technologies
- restorative material modifications

give rise to a new “bundle package industry”

Patient

Dentist

Dental
Technician

Prosthesis
designing

Biomaterial
selection

Fabrication
process

Patient

Dentist

Dental
Technician

Prosthesis
designing

Biomaterial
selection

Fabrication
process

Prefabricated blanks for customised implant abutments



ESSENTIAL:

- It's the Doctor's responsibility to maintaining the control of and overview of the chain of materials and fabrication methods
- Fabrication processes and material choices may be incompatible
- Stay with a validated concept or upgrade your knowledge about modern material properties as well as modern additive & subtractive manufacturing methods

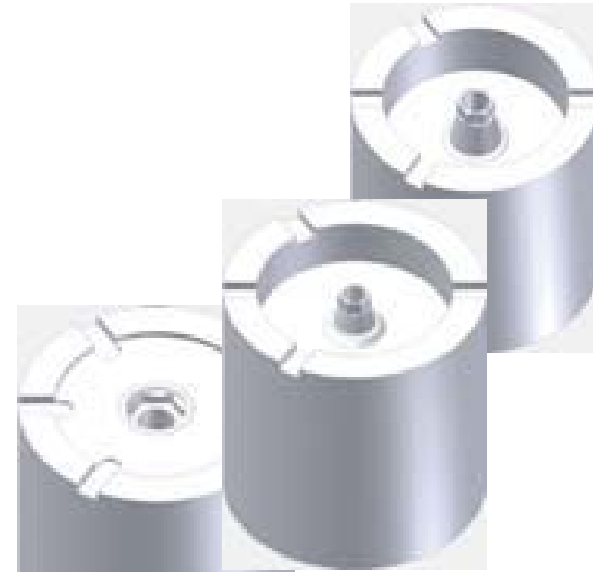

OUR DENTAL TEAM

PARTNERS – A CONCERN

OCCUPATIONAL OUTLOOK HANDBOOK

Search Handbook

Healthcare >

Dentists

FONT SIZE: [PRINTER-FRIENDLY](#)

Summary	What They Do	Work Environment	How to Become One	Pay	Job Outlook	Similar Occupations	Contacts for More Info
----------------	--------------	------------------	-------------------	-----	-------------	---------------------	------------------------

Summary

Quick Facts: Dentists

2010 Median Pay	\$146,920 per year \$70.64 per hour
Entry-Level Education	Doctoral or professional degree
Work Experience in a Related Occupation	None
On-the-job Training	Internship/residency
Number of Jobs, 2010	155,700
Job Outlook, 2010-20	21% (Faster than average)
Employment Change, 2010-20	32,200



Occupational Outlook of members of the Dental Team (in USA)

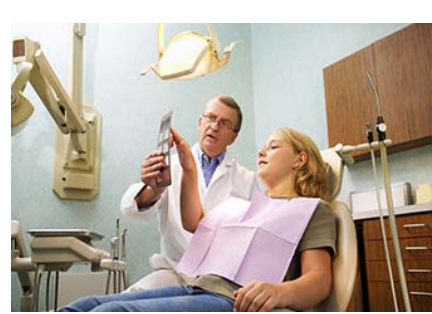

Quick Facts: Dentists	
2010 Median Pay ?	\$146,920 per year \$70.64 per hour
Entry-Level Education ?	Doctoral or professional degree
Work Experience in a Related Occupation ?	None
On-the-job Training ?	Internship/residency
Number of Jobs, 2010 ?	155,700
Job Outlook, 2010-20 ?	21% (Faster than average)
Employment Change, 2010-20 ?	32,200



Quick Facts: Dental Hygienists	
2010 Median Pay ?	\$68,250 per year \$32.81 per hour
Entry-Level Education ?	Associate's degree
Work Experience in a Related Occupation ?	None
On-the-job Training ?	None
Number of Jobs, 2010 ?	181,800
Job Outlook, 2010-20 ?	38% (Much faster than average)
Employment Change, 2010-20 ?	68,500



Quick Facts: Dental Assistants	
2010 Median Pay ?	\$33,470 per year \$16.09 per hour
Entry-Level Education ?	Postsecondary non-degree award
Work Experience in a Related Occupation ?	None
On-the-job Training ?	None
Number of Jobs, 2010 ?	297,200
Job Outlook, 2010-20 ?	31% (Much faster than average)
Employment Change, 2010-20 ?	91,600



Quick Facts: Dental Laboratory Technicians	
2010 Median Pay ?	\$35,140 per year \$16.90 per hour
Entry-Level Education ?	High school diploma or equivalent
Work Experience in a Related Occupation ?	None
On-the-job Training ?	Moderate-term on-the-job training
Number of Jobs, 2010 ?	40,900
Job Outlook, 2010-20 ?	1% (Little or no change)
Employment Change, 2010-20 ?	300

Source: U.S. Department of Labor, Bureau of Labor Statistics, Occupational Outlook Handbook, 2012-13 Edition

Dental Laboratory Technicians

- Summary
- What They Do
- Work Environment
- How to Become One
- Pay
- Job Outlook**
- Similar Occupations
- Contacts for More Info

Job Outlook

About this section

Employment of dental laboratory technicians is expected to experience little or no change from 2010 to 2020.

As cosmetic prosthetics, such as veneers and crowns, become less expensive, there should be an increase in demand for these appliances. Accidents and poor oral health, which can cause damage and loss of teeth, will continue to create a need for dental laboratory technician services. Dental technician services will be in demand, as dentists work to improve the aesthetics and function of patients' teeth.

On the other hand, baby boomers and their children are more likely to retain their teeth than previous generations. This is due to increased visits to dentists, increased use of fluoride, and more dental health education. These factors will likely lead to a decrease in the number of full and partial dentures and other prosthetics used to replace missing teeth and will temper demand for the technicians that make them.

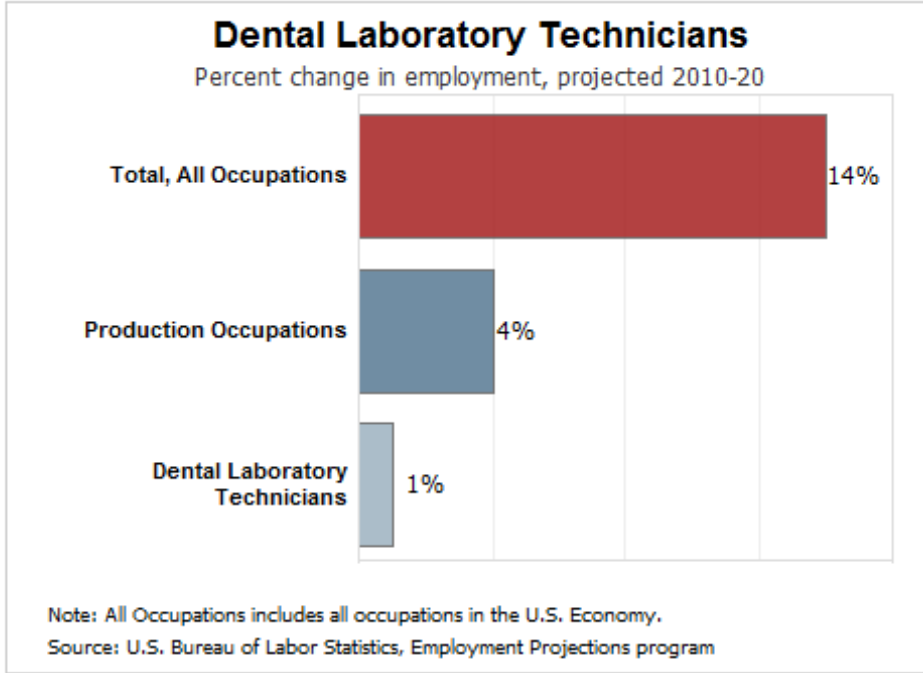

Employment projections data for dental laboratory technicians, 2010-20

Occupational Title	SOC Code	Employment, 2010	Projected Employment, 2020	Change, 2010-20		Employment by Industry
				Percent	Numeric	
Dental Laboratory Technicians	51-9081	40,900	41,200	1	300	[XLS]

SOURCE: U.S. Bureau of Labor Statistics, Employment Projections program

Technicians unskilled labor? Not likely.

NADL Fights Unskilled Labor Label for Technicians

A federal shuffle has reclassified dental technicians as unskilled labor, a false label that could have far-reaching effects on the profession. NADL is lobbying the U.S. Department of Labor to restore technicians to the skilled labor category.

“The proposed classification change for dental technicians to another occupational rating could adversely affect the ability of economic

- Typical Entry-Level Education: High school diploma or equivalent
- Previous Work Experience in a Related Occupation: None
- State Licensing: Yes (Editor’s Note: A few states require laboratories or technicians to be registered or certified.)



EAO, København, 2012



Thank you
for your
kind
attention